

Osaki

Instruction Manual

Model No. OS-3D Otamic LE

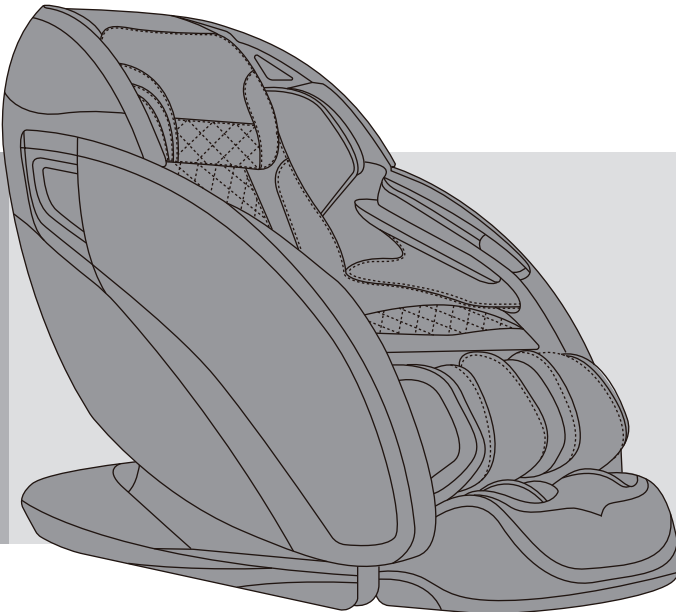

Before operating this unit, please read these instructions completely.

Contents

Before Use

Safety Precautions	1-4
• FCC Radiation Exposure Statement	4
Chair Components	5-7
• Bluetooth Speaker	6
Chair installation	8
Preparation before Use	9-10
Moving the massage chair	11

How to Use

Armrest Controller	12
Remote Controller	13-18

Q&A / Important

Cleaning and maintenance	19
Troubleshooting	20
Grounding Instructions.....	21
Chair Specifications.....	22

Thank you for purchasing **this** Massage Chair.
Before using your massage chair, please read the contents of this
instruction manual and refer to it when needed.

IMPORTANT SAFETY INSTRUCTIONS

When using an electrical appliance, basic precautions should always be followed, including the following:

Read all instructions before using (this appliance).

DANGER To reduce the risk of electric shock:

- Always unplug this appliance from the electrical outlet immediately after using and before cleaning.
- Never use pins or other metallic fasteners with this appliance.
- Carefully examine the covering before each use. Discard the appliance if the covering shows any sign of deterioration, such as checking, blistering, or cracking.

WARNING To reduce the risks of burns, fire, electric shock or injury to persons:

- An appliance should never be left unattended when plugged in. Unplug from outlet when not in use, and before putting on or taking off parts.
- Close supervision is necessary when this appliance is used by, on, or near children, or disabled persons.
- Use this appliance only for its intended use as described in this manual. Do not use attachments unless recommended by the manufacturer.
- Never operate this appliance if it has a damaged cord or plug, if it is not working properly, if it has been dropped or damaged, or dropped into water. Return the appliance to a service center for examination and repair.
- Do not carry this appliance by the supply cord or use cord as a handle.
- Keep the cord away from heated surfaces.
- Never operate the appliance with the air openings blocked. Keep the air openings free of lint, hair, and the like.
- Never drop or insert any object into any opening.
- Do not use outdoors.
- Do not operate where aerosol (spray) products are being used.
- To disconnect, turn all controls to the off position, then remove plug from outlet.
- Keep children away from extended foot support/rest.
- Connect this appliance to a properly grounded outlet only. See Grounding Instructions.
- Use the heated surfaces carefully. May cause serious burns. Do not use over sensitive skin areas or in the presence of poor circulation. The unattended use of heat by children or persons may be dangerous.
- Do not operate under blanket or pillow. Excessive heating can occur and cause fire, electric shock, or injury to persons.

SAVE THESE INSTRUCTIONS

Safety Precautions

When using the massage chair, basic precautions should always be followed to reduce the risk of electric shock, burns, fire or injury to persons. Please read the following precautions before using the massage chair.

- Make sure the power plug is securely inserted into a proper electrical outlet to reduce the risk of short-circuit and fire.
- It is highly recommended that a surge protector is used to prevent from damage.
- DO NOT use the massage chair in areas where the humidity is high such as sauna steam rooms, pools, bathrooms, AC or heating vents, etc.
- DO NOT use the massage chair outdoors and avoid areas with direct sunlight.
- If the chair is not being used, turn the power switch to the OFF position and unplug the massage chair from the electrical outlet to prevent any damages to the chair when there are power outages/surges that may cause serious damage.
- Never plug/unplug the power cord plug socket with wet hands.
- Close and continuous supervision is necessary when the massage chair is used by, on or near children or disabled persons.
- No more than one person should use the massage chair at the same time.
- The massage chair is intended for use as described in the Instruction Manual. Do not use any attachments other than those recommended by the manufacturer.
- DO NOT attempt to stand or sit on the backrest, armrest or footrest in order to prevent accident, injury or damage to the chair.
- Avoid falling asleep while using the massage chair.
- Always keep the massage chair clean, and never insert any objects into or around the gaps of the massage chair.
- DO NOT move the massage chair by pulling on the power supply cord.
- Make sure there are no children, pets or other obstacles behind or underneath the massage chair.
- If you find any rips or tears in the fabric of the massage chair, contact the service department and stop using the chair immediately.
- This massage chair is designed for household use and should not be used in non-residential settings.

Safety Precautions

- Please consult your doctor if you are in doubt as to whether or not you should use this massage chair.
- Please consult a doctor before using the massage chair if you are pregnant, undergoing any medical treatment, using a medical electronic device such as a pacemaker, or are experiencing any of the following: malignant tumor, heart disease, back pain, abnormal or curved back bone, osteoporosis or acute illness.
- If you experience pain while using the massage chair, stop using the chair immediately and consult your doctor.
- Never use a massage function on swollen or inflamed parts of the body.
- DO NOT use the massage chair for more than 30 minutes at a time.
- DO NOT use the massage chair where aerosol(spray) products are being used or where oxygen is being administered.
- This massage chair is a non-professional product designed to provide a comfortable massage and should not be substituted for appropriate medical treatment.
- Never operate the appliance with the air hoses that inflate while they are blocked. Keep the air openings free of lint, hair, and any other obstructions.
- Check the skin which is in contact with the heated area of the appliance frequently to reduce the risk of injury. If the heating pad malfunctions and extreme heat is produced it may cause serious burns.
- Burns may result from improper use. If this is the case immediately shut off the chair and unplug from the outlet.
- Remove all sharp objects from the body and pockets such as keys and pens.
- Keep children away from extended foot support (or other similar parts.)
- DO NOT WET-DO NOT USE PINS.
- NEVER REMOVE COVER.

Caution

The user's weight is usually limited to 264 lbs.

For those who are weighing 264 lbs or more, the product operations may make more noise and the fabric cover may wear out faster.

FCC Radiation Exposure Statement

FCC Radiation Exposure Statement:

This equipment complies with FCC radiation exposure requirement.
The device can be used in portable exposure condition without RF striction.

FCC STATEMENT

1. This device complies with Part 15 of the FCC Rules. Operation is subject to the following two conditions:
 - (1) This device may not cause harmful interference, and
 - (2) This device must accept any interference received, including interference that may cause undesired operation.
2. Changes or modifications not expressly approved by the party responsible for compliance could void the user's authority to operate the equipment.

This equipment has been tested and found to comply with the limits for a Class B digital device, pursuant to part 15 of the FCC Rules. These limits are designed to provide reasonable protection against harmful interference in a residential installation. This equipment generates, uses and can radiate radio frequency energy and, if not installed and used in accordance with the instructions, may cause harmful interference to radio communications. However, there is no guarantee that interference will not occur in a particular installation. If this equipment does cause harmful interference to radio or television reception, which can be determined by turning the equipment off and on, the user is encouraged to try to correct the interference by one or more of the following measures:

- Reorient or relocate the receiving antenna.
- Increase the separation between the equipment and receiver.
- Connect the equipment into an outlet on a circuit different from that to which the receiver is connected.
- Consult the dealer or an experienced radio/ TV technician for help.

Chair Components

Front

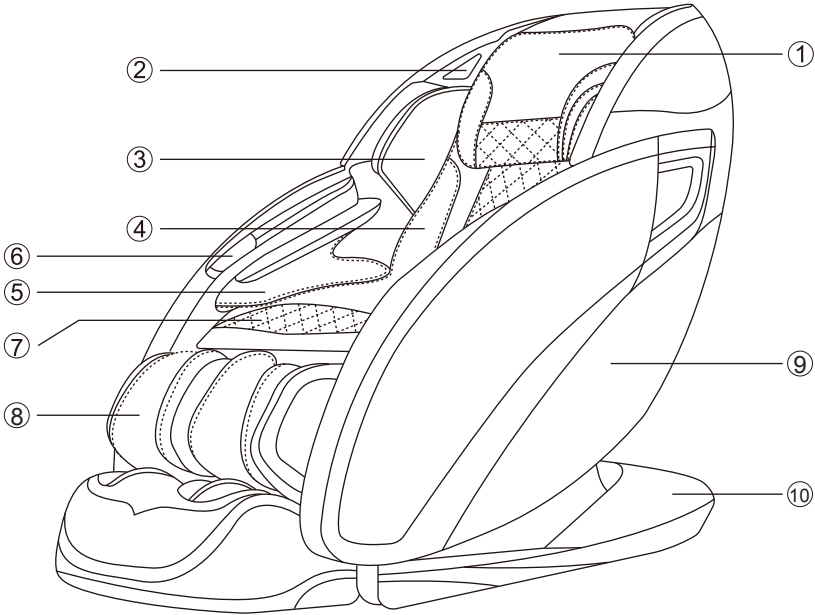

① Pillow Pad

③ Shoulder side massage section

⑤ Hand and arm massage section

⑦ Seat

⑨ Side Panel

② Bluetooth Speaker

④ Backrest Pad

⑥ Armrest Controller

⑧ Legrest

⑩ Power Box

Chair Components

Bluetooth Speaker

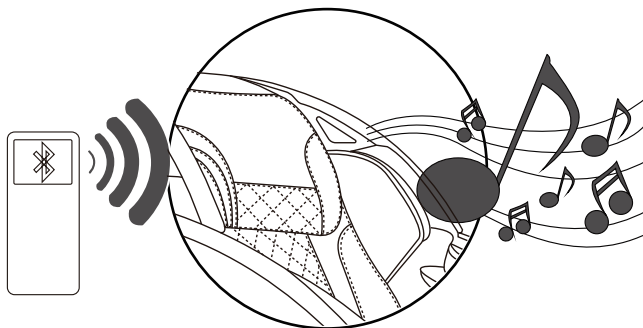



NOTE:

The bluetooth speaker can only connects with one bluetooth device at a time. Please turn off your bluetooth device after using so that other users can enjoy it as well.

Chair Components

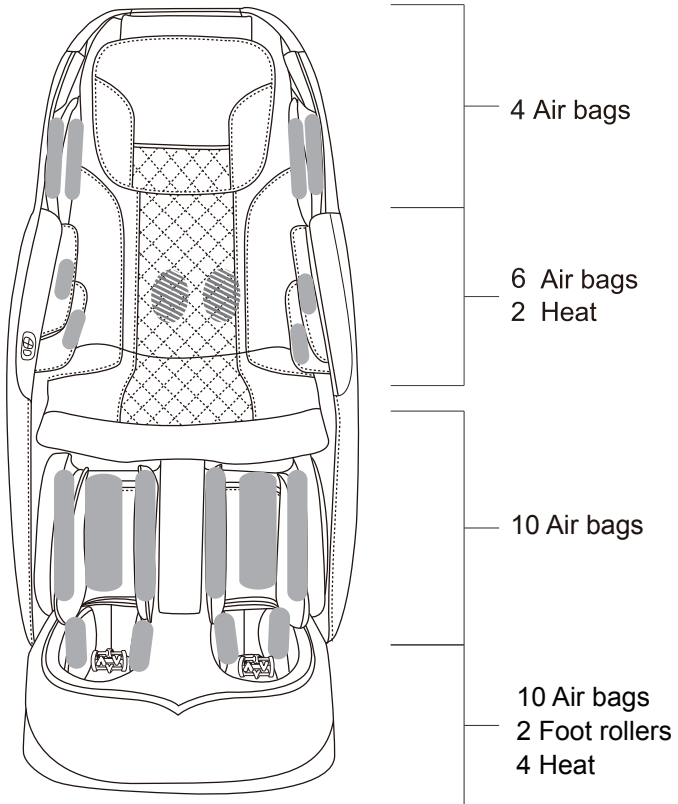
Air Massage Area



 Air bag

 Heat

 Foot Roller

Chair installation

(1) Take the footrest down to the floor slowly.

(2) Connect the backrest pad both sides to the chair by zipper. Connect the backrest pad and footrest cover with zipper.

(1)

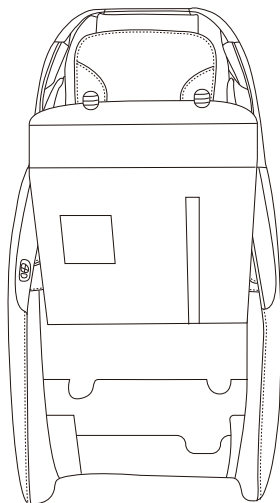

(2)

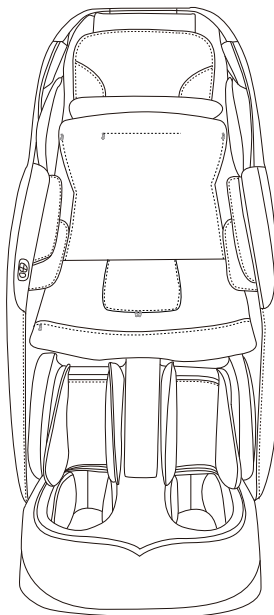

Preparation before Use

1. Chair placement

- When placing the massage chair, be sure to leave 2 in. of space between the back of the chair and wall or any other objects to allow it recline safely.
- When using the massage chair, ensure there are no people, pets, or objects within 20 in. of the chair to allow the footrest extend safely.

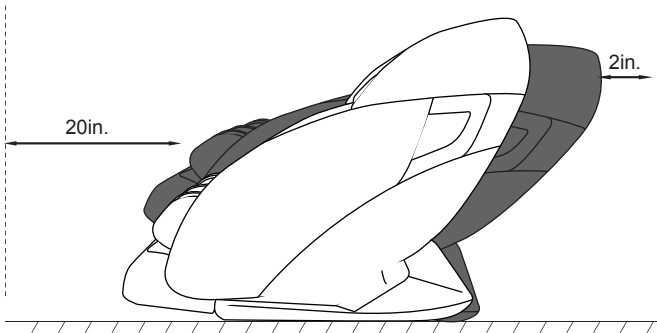

2. Check the space around the product.

Make sure there is no person, pet, or other object close to the product.

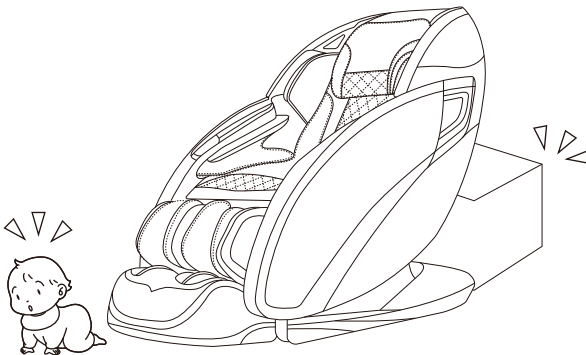

Preparation before Use

3. Make sure there is no foreign matter in the seams of the product.

- Before sitting on the product, make sure there is no foreign matter between any two parts of it.
- Do not put hands, arms or head between the backrest and the back cover.
- Do not put pets on the product (such as its back cover, backrest and armrests).

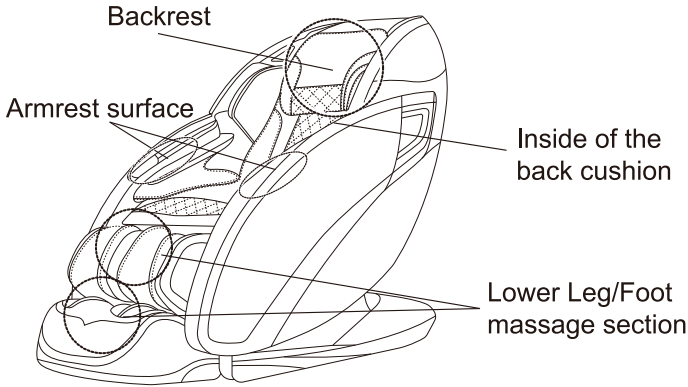

4. Power on the product

- ① Push the power connector into the appliance inlet till the end.
- ② Insert the power plug into the power outlet till the end.
- ③ Turn the switch to "I" position

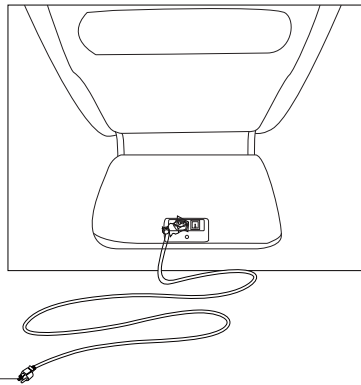
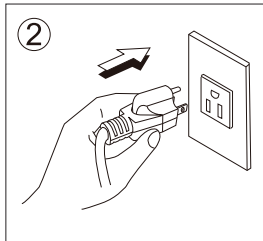
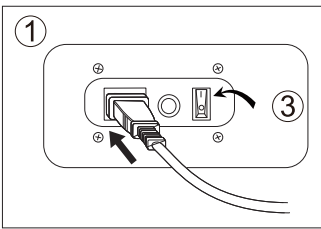

Moving the massage chair

- Before moving the chair, please switch off the power and remove the power cord from socket.
- Lower the chair by the backrest until the base is inclined at a 45° angle.
- Move the chair carefully by the caster.

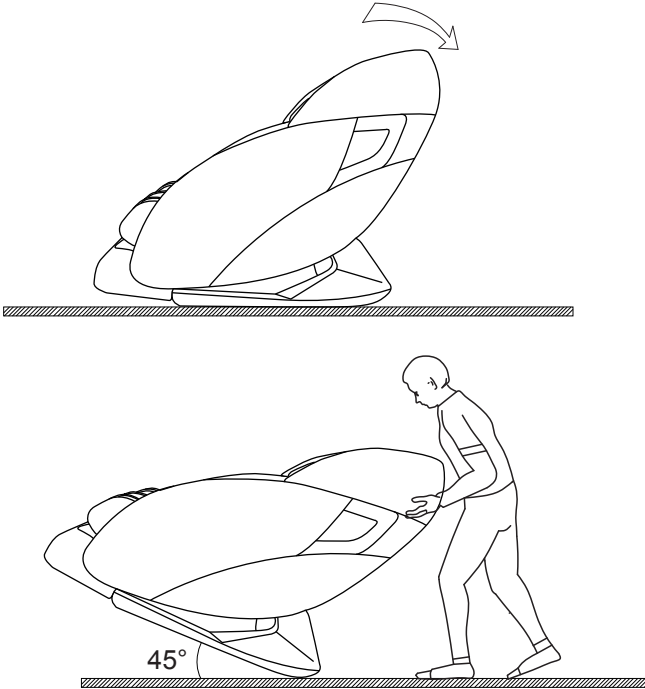

How to use

Armrest Controller

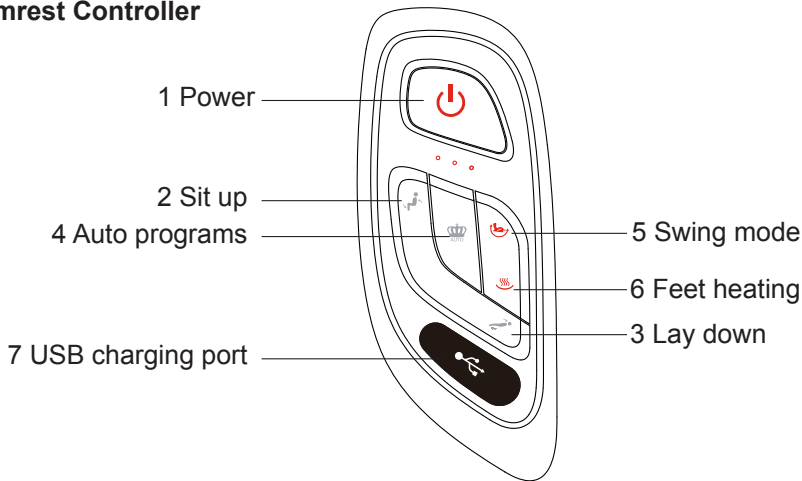

Programs Description

1. Power

- Starts and stops all functions of the massage chair.
- Press once. Remote control will light up and chair will be in idle mode.
- You can press any massage function buttons to begin your massage session, at a default time of 15 minutes.
- Press again, all functions will stop and massage rollers will return to original position.

2/3: Sit up/Lay down

- Press this button to sit up or lay down.
- Press again to stop at the angle you like.

4. Auto programs

- Press this button to start auto programs. Each time you press, it will switch among 10 auto programs one by one.

5. Swing

- Press this button to start Swing mode. There are 3 levels for selection. Each time you press, it will switch one by one.

6. Feet heating

- Press this button to start feet heating. Press again to stop.

7. USB charging port

- Connect your electronic devices with USB cable for charging.

How to use

Remote Controller

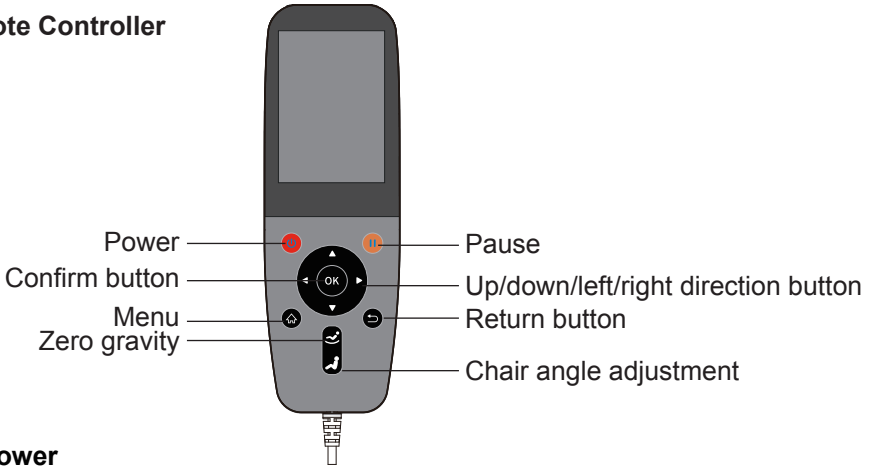

Power

Same as above in page 12.

Pause

- All massage functions will stop temporarily.
- Press once and the Pause icon will light up.
- Massage functions and timer will be stopped temporarily.
- Press again to resume the massage session.

Direction buttons

- Press these direction buttons in menu could choose different options you want, and then press “OK” button to confirm.

Menu

- Press this button could return to menu page. Then choose different functions you like.

Return

- Press this button could return to last menu. Press several times could return to menu page finally.

Zero gravity & Chair angle adjustment

Zero gravity

- Press this button chair will recline to Zero gravity angle. There are 3 levels.
- Each time you press, it will switch one by one.

Chair angle adjustment

- Press this button to enter in angle adjustment page. You could adjust the angle as you like for better massage.

How to use

Settings

Choose the functions with direction buttons and press “OK” to confirm.

- Language: Select the language.
- Screen Sleep: Adjust the Screen Sleep time.
- LED: Choose different LED color and mode.
- Time adjustment: 5/10/15/20/30 minutes.
- Screen brightness: Adjust screen brightness.



How to use

Foot massage

- Choose foot massage with direction buttons and press “OK” to start.
- Choose different foot air massage intensity with direction buttons.



- When you choose the auto programs, the chair will detect your shoulder position automatically. You could adjust the massage roller higher or lower with direction buttons after you hear the “BIBI” voice.



Zero gravity

- Reset: Massage roller, backrest and footrest will return to original position.
- Zero gravity: Chair will recline to Zero gravity position. 2 levels option.

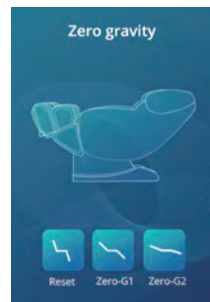

How to use

Heating

- Choose heating function with direction buttons and press “OK” to confirm.
- Waist/Foot heating: ON/OFF the heating function.

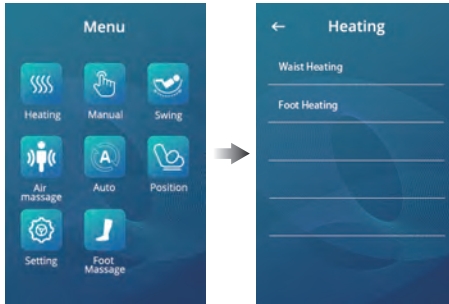

Manual programs

Choose manual programs by direction buttons and press “OK” to confirm.

- Manual: Choose different massage style. The speed and strength could be adjusted.
- Region: Choose different body part for massage.

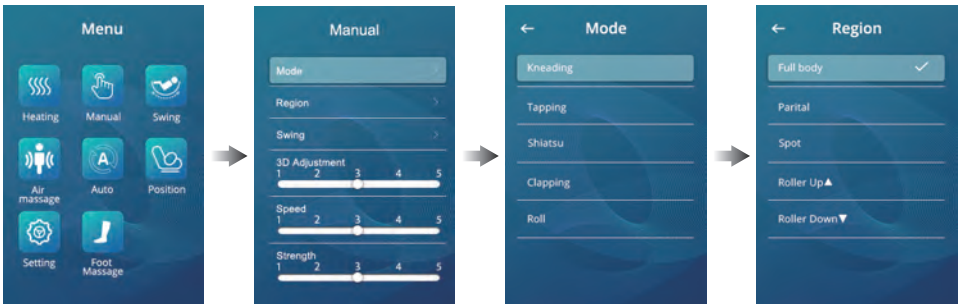

How to use

Swing

Choose Swing mode with direction buttons and press “OK” to confirm.

- Cradle mode: It is suggested using at afternoon or night.

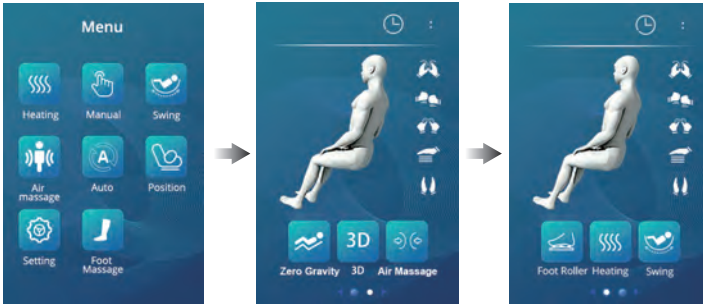

Air massage

Choose Air massage with direction buttons and press “OK” to confirm.

- Air massage position: Choose different air massage position.
- Air intensity: 1-5 levels adjustment.

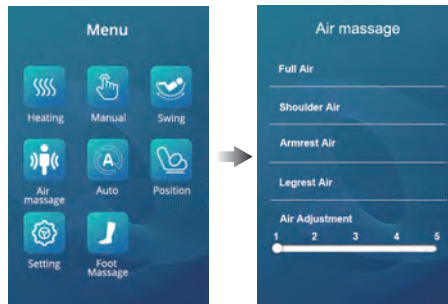

How to use

Auto programs

- Choose auto programs with direction buttons and press “OK” to confirm.
- 9 auto programs.

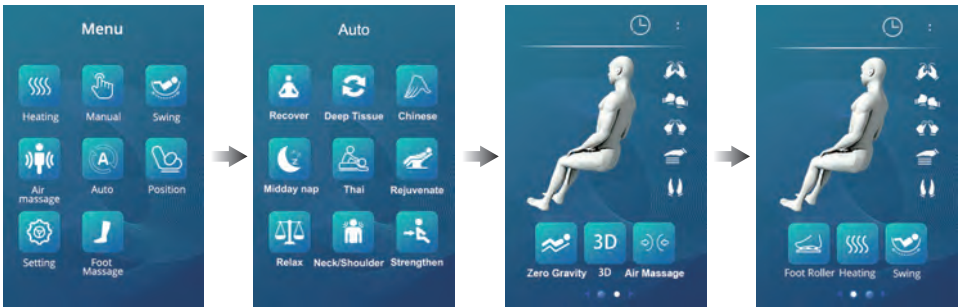

Position adjustment

Choose position adjustment with direction buttons and press “OK” to confirm.

- Position adjustment: Adjust the backrest and footrest angle for better massage.



Bluetooth music speaker

Bluetooth music speaker: Firstly open the mobile device Bluetooth function and then match the chair Bluetooth name "OMCXXXX". After connection, you could display music with chair speaker.

Cleaning and maintenance

1. Cleaning of the synthetic leather

• Wipe the synthetic leather with a soft dry cloth.

- Do not clean the product with chemicals such as thinners, gasoline and alcohol.
- When using a leather maintenance product (cleaning cloth) sold on the market, follow its directions for use.
- If the synthetic leather is very dirty, wipe it with the method below.

- ① Put a piece of soft cloth into water or 3% to 5% neutral detergent contained hot water and wring it out.
- ② Wipe surface of the synthetic leather with the soft cloth.
- ③ Wipe the detergent with a piece of cloth once soaked in clean water and wrung out.
- ④ Wipe with a piece of wrung soft cloth.
- ⑤ Have the synthetic leather take natural air drying.

• If it is difficult to remove the stains on the synthetic leather, soak a piece of melamine foam bought from the market into a neutral detergent and use it wipe the product.

- Do not dry the surface by a hair drier.
- Surface of the synthetic leather may be dyed by fabric colors; therefore, be careful when wiping the product with denim or colored cloth.
- Synthetic leather may discolor, so the position in contact with the hair dye used should be covered by a towel.

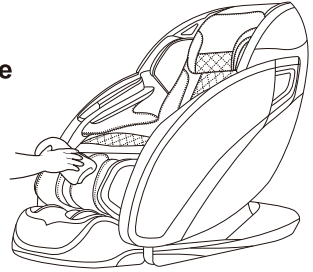

2. Cleaning of the plastic parts

1) Put a piece of soft cloth into water or neutral detergent contained hot water, wring it out and wipe the plastic parts.

- Do not clean the product with chemicals such as thinners, gasoline and alcohol.

2) Wipe with a piece of cloth once soaked in clean water and wring out.

- Wring the cloth out before using it to wipe the remote controller.

3) Have the plastic parts air dried

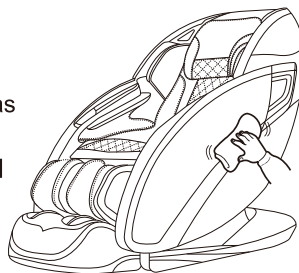

Troubleshooting

This page summarizes the most common problems you could encounter with the product. If you are unable to solve the problem with the information below, contact service center immediately.

If the problem encountered is not listed, please try the following suggestions:

1. Turn off the product and unplug it.
2. Wait for 60 minutes.
3. Plug the product back to the recommended outlet and restart.
4. If the problem persists, contact the authorized service center.

Problem	Possible Cause	Suggestion
The product does not work	The product is not plugged in properly.	Ensure the voltage on the product corresponds to the local mains voltage and then plug in again. Make sure the outlet is properly working.
The product stopped working	The product has just finished its auto timer session and has automatically switched to standby mode.	If you want another session, press the Power button again.
The product stopped working	You may have used the product continuously for 45 minutes where the over heat protection has been activated.	Unplug the product and let it cool down for 60 minutes before you use it again.
The product does not work	An excessive load has been applied on the product.	Reduce the excessive load and start again.
The product is abnormally warm	The product is likely to be overused.	Unplug the product and let it cool down before using it again.
Noise can be heard from the product	Noise is made by the mechanical parts of the product.	This is normal and does not mean that the product is faulty.

Grounding Instructions

This product must be grounded. If it should malfunction or break down, grounding provides a path of least resistance for the electric current to reduce the risk of electric shock. This product is equipped with a cord with an equipment-grounding conductor and a grounding plug. The plug must be plugged into an appropriate outlet that is properly installed and grounded in accordance with all local codes and ordinances.

Danger-Improper connection of the equipment-grounding conductor can result in a risk of electric shock. Check with a qualified electrician or service technician if the product will not fit the outlet, have a proper outlet installed by a qualified electrician.

This product is for use on a nominal 120V circuit and has grounding plug that looks like that plug illustrated below. Make sure that the product is connected to an outlet having the same configuration as the plug. No adapter should be used with this product.

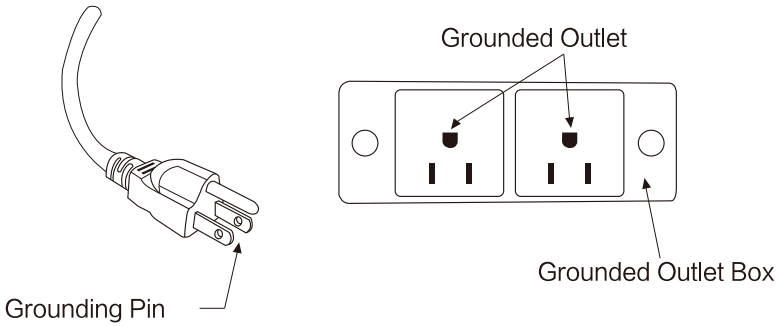

Chair Specifications

Description	Specifications
Model No.	OS-3D Otamic LE
Rated Voltage	110-120V~
Rated Frequency	60Hz
Rated Power Consumption	150W
Timer	5/10/15/20/30 minutes
Rated Time	15 minutes
Dimensions(L x W x H)	Upright: 62" x 29.5" x 46.5"
	Reclined: 67.7" x 29.5" x 34"
Weight	Gross Weight: Approx. 250.8 lbs
	Net Weight: Approx. 220 lbs
Length of Wire	Controller wire: 32"
	Power supply wire: 70.9"
Usage Condition	Environment temperature: 32°F~95°F
	Contrasting humidity: 20-80RH
Storage Condition	Storage temperature: 32°F~95°F
	Storage humidity: 20-80RH
Safety Feature	Equipped with overheated and power
Maximum body weight of user	264 lbs

Issued.2020.01
V1.0