

Osaki

4D Bravo Duo[®]

INSTRUCTION MANUAL

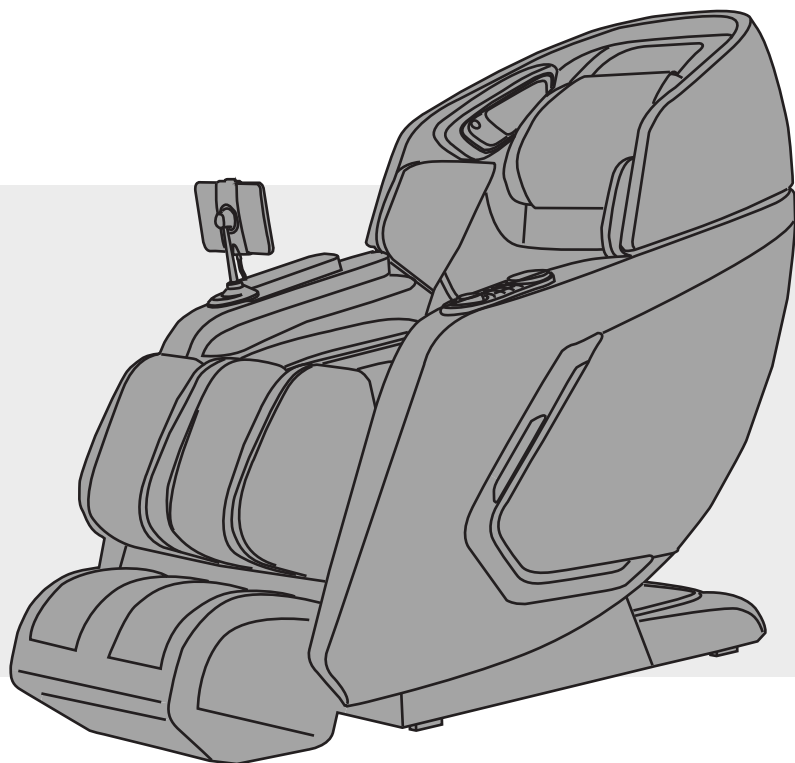

Please read all instructions carefully before using.

IMPORTANT SAFETY INSTRUCTIONS

When using an electrical appliance, basic precautions should always be followed, including the following: Read all instructions before using (this appliance).

DANGER – To reduce the risk of electric shock:

1) Always unplug this appliance from the electrical outlet immediately after using and before cleaning.

WARNING – To reduce the risk of burns, fire, electric shock, or injury to persons:

1) An appliance should never be left unattended when plugged in. Unplug from outlet when not in use, and before putting on or taking off parts.

2) Do not operate under blanket or pillow. Excessive heating can occur and cause fire, electric shock, or injury to persons.

3) Close supervision is necessary when this appliance is used by, on, or near children, invalids, or disabled persons. Keep children away from extended foot support (or other similar parts).

4) Use this appliance only for its intended use as described in this manual. Do not use attachments not recommended by the manufacturer.

5) Never operate this appliance if it has a damaged cord or plug, if it is not working properly, if it has been dropped or damaged, or dropped into water. Return the appliance to a service center for examination and repair.

6) Do not carry this appliance by supply cord or use cord as a handle.

7) Keep the cord away from heated surfaces.

8) Never operate the appliance with the air openings blocked. Keep the air openings free of lint, hair, and the like.

9) Connect this appliance to a properly grounded outlet only. See Grounding Instructions.

10) Never drop or insert any object into any opening.

11) Do not use outdoors.

12) Do not operate where aerosol (spray) products are being used or where oxygen is being administered.

13) To disconnect, turn all controls to the off position, then remove plug from outlet.

14) Use heated surfaces carefully. May cause serious burns. Do not use over insensitve skin areas or in the presence of poor circulation. The unattended use of heat by children or incapacitated persons may be dangerous.

15) Do not use massager in close proximity to loose clothing or jewelry.

16) Keep long hair away from massager while in use.

SAVE THESE INSTRUCTIONS

Household use only

Thank you for purchasing this product.

Please read this user manual carefully before using to ensure proper installation and operation.

Please keep this USER MANUAL properly for future reference.



▶ CONTENTS

SAFETY PRECAUTIONS	1
NAME AND FUNCTION OF EACH COMPONENT	3
External Structure	3
Internal Structure	3
Armrest Quick Buttons	4
Instructions of Armrest Quick Button	5
Offline Voice Control	6
Tablet instruction	7
Functions And Features	8
PRELIMINARY CHECKS	9
Position & Placement for Installation	9
Installation Method	10
Floor Protection	12
Surrounding Environment	12
Grounding	12
Moving the Massage Chair	13
Connecting to Power	13
Commissioning	14
Before Sitting in the Chair	14
Footrest Extension	15
Audio Function	15
After Use	15
PRODUCT STORAGE AND MAINTENANCE	16
TROUBLESHOOTING	17
PRODUCT SPECIFICATIONS	18

SAFETY PRECAUTIONS

Safety Precautions

- ▶ Before using, please read the SAFETY PRECAUTIONS carefully to ensure correct operation of this appliance.
- ▶ Precautions and warnings listed below will help to ensure proper operation of this appliance.
- ▶ The classes of accidents caused by incorrect use are classified into WARNING and CAUTION. Read all WARNINGS and CAUTIONS below and follow all instructions within this manual.

	WARNING	Improper operation may cause injury to users.
	CAUTION	Improper operation may cause injury to users or damage to product.

	Prohibited		NO Disassemble
---	------------	---	----------------

Not suitable for below persons

We recommend that those with any of the following conditions should consult your physician before using.

 WARNING	<ul style="list-style-type: none"> ◆ Those with pacemaker or electronic devices implanted in the body. ◆ Those undergoing treatment, especially those who are not feeling well. ◆ Those with malignant tumors, acute disease, heart disease or severe hypertension. ◆ Need to be supervised. ◆ Women who are pregnant or menstruating. ◆ Those with osteoporosis, distorted joints, dysfunction or recent fracture. ◆ Those with serious or injured skin conditions. ◆ Those with high fever. ◆ The appliance has a heated surface. Persons insensitive to heat must be careful when using the appliance. (Need to be supervised) ◆ This appliance is not intended for use by persons (including children) with reduced physical, sensory or mental capabilities, or lack of experience and knowledge, unless they have been given supervision or instruction concerning use of the appliance by a person responsible for their safety. ◆ This appliance can be used by children aged from 8 years and above and persons with reduced physical, sensory or mental capabilities or lack of experience and knowledge if they have been given supervision or instruction concerning use of the appliance in a safe way and understand the hazards involved.
---	---

Controller Precautions

 CAUTION	<ul style="list-style-type: none"> ◆ Do not operate the controller with wet hands or pull the controller wire by force. ◆ Do not spill water or other liquid into the controller to avoid fault. ◆ Do not lay heavy items on the controller.
---	---

Cautions Regarding the Power Connectors and Power Cord





 CAUTION	<ul style="list-style-type: none"> ◆ The appliance is only to be used with the power supply unit provided with the appliance. ◆ It must only be supplied at safety extra low voltage corresponding to the marking on the appliance. ◆ Do not use a wet hand to unplug the AC cord to avoid electric shock. ◆ Do not pull on the power cord, reach to the front end to unplug it. ◆ Do not squeeze the power cord by heavy objects. ◆ Do not damage, over bend, pull hard or twist the power cord. ◆ If the supply cord is damaged, it must be replaced by the manufacturer or its service agent or a similarly qualified person in order to avoid a hazard.
---	--

SAFETY PRECAUTIONS

Best Circumstances

 CAUTION	<ul style="list-style-type: none"> ◆ Do not use this appliance where temperature is over 40 C . ◆ Do not use this appliance in moist or dusty environment. ◆ Unplug from outlet during thunder or lightening storms. ◆ Do not use outdoors. ◆ Please place the product on the flat level floor. ◆ Do not store near heat or open flame.
---	---

Best Practices for Safe Use

 CAUTION	<ul style="list-style-type: none"> ◆ Only for users weighs below 120kg. ◆ Do not use other therapeutic device together with this product. ◆ Use this product only for its intended use as described in this manual. ◆ Appliance should only be used by one person,do not use by two or more persons at the same time to avoid damage to the products. ◆ Do not use the product right after meal, it may cause discomfort. ◆ Remove the accessories from the arms and empty the pockets while use the massage services. ◆ Check the upholstery under the cushions and other spots, if any damages are present, do not use it and refer to a qualified service professional for servicing. ◆ If you feel any abnormal discomfort during the operation of this product, turn off the power immediately and do not use the product. ◆ Use the appliance for 20 minutes each time is highly recommended. ◆ Make sure there is no obstacles behind the chair and there is enough clearance before adjusting the backrest or footrest angle ◆ Make sure no other excessive load pressed on the backrest or footrest,keep children,pets or any other barrier away from the unit reclining backrest/extending footrest to prevent any accidental injury. ◆ Please be seated properly while using the appliance to avoid injury to the user or damage to the appliance. ◆ Do not drag or push the chair or roll on its casters on wood floor or carpet to avoid damage.
 PROHIBITED	<ul style="list-style-type: none"> ◆ Never operate this product if it has damaged /exposed parts or power leakage. ◆ Do not stand on or stack heavy objects on the footrest. ◆ Children should be supervised to ensure that they do not play with the massage chair. ◆ Do not fall into sleep while the product is operating. ◆ Avoid using the product under the influence of alcohol. ◆ Do not put hands or foreign objects in the openings of the appliance to avoid injury to the user or damage to the appliance. ◆ If there is any smoke or unusual smell during operation,stop using immediately.
 NO DISASSEMBLE	<ul style="list-style-type: none"> ◆ Do not disassemble this product to avoid failure. ◆ Do not attempt to repair or dismantle the appliance without permission. ◆ Please contact authorized dealer or service agent.
 UNPLUG POWER CORD	<ul style="list-style-type: none"> ◆ Pull out the power cord from the power strips before maintenance. ◆ Never plug in or pull out power cord with wet hand to avoid shock or injury. ◆ Pull out the power cord from the power strips after use. ◆ Unplug from outlet when the power supply is cut.

NAME AND FUNCTION OF EACH COMPONENT

External Structure

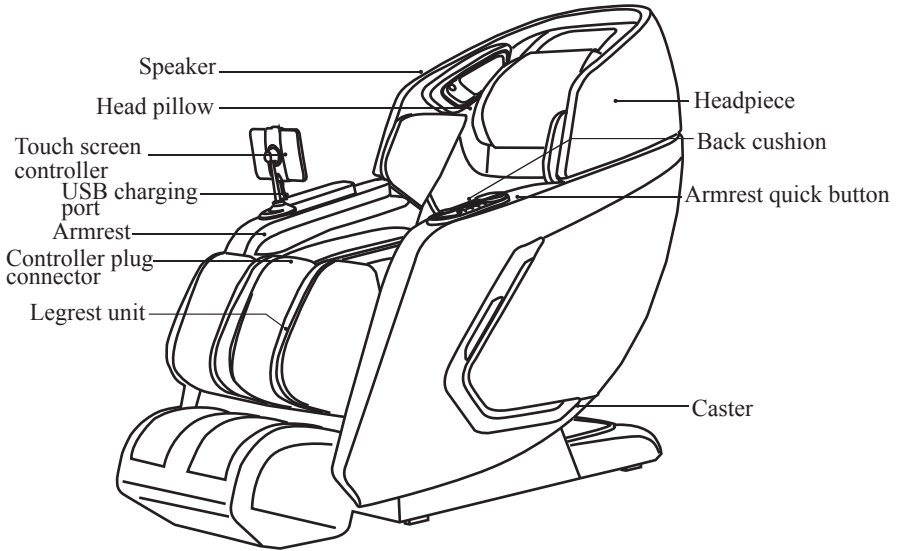

Internal Structure

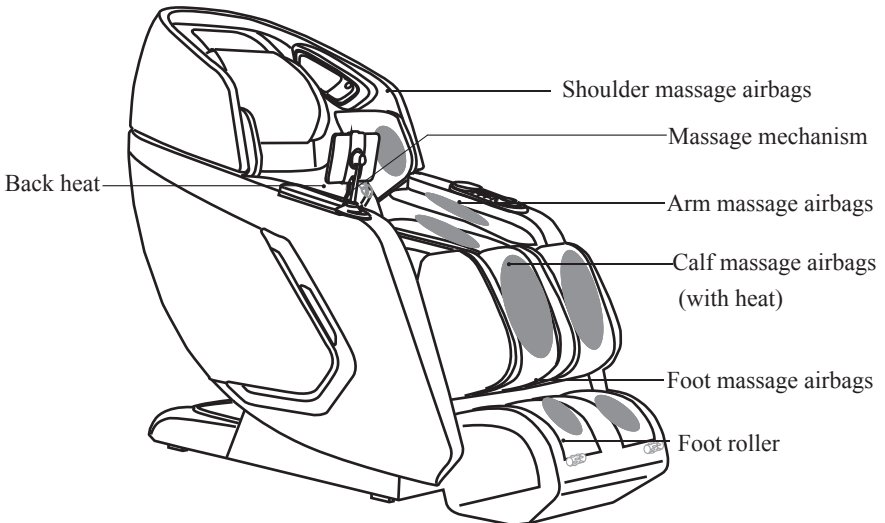

▶ NAME AND FUNCTION OF EACH COMPONENT

Armrest Quick Buttons

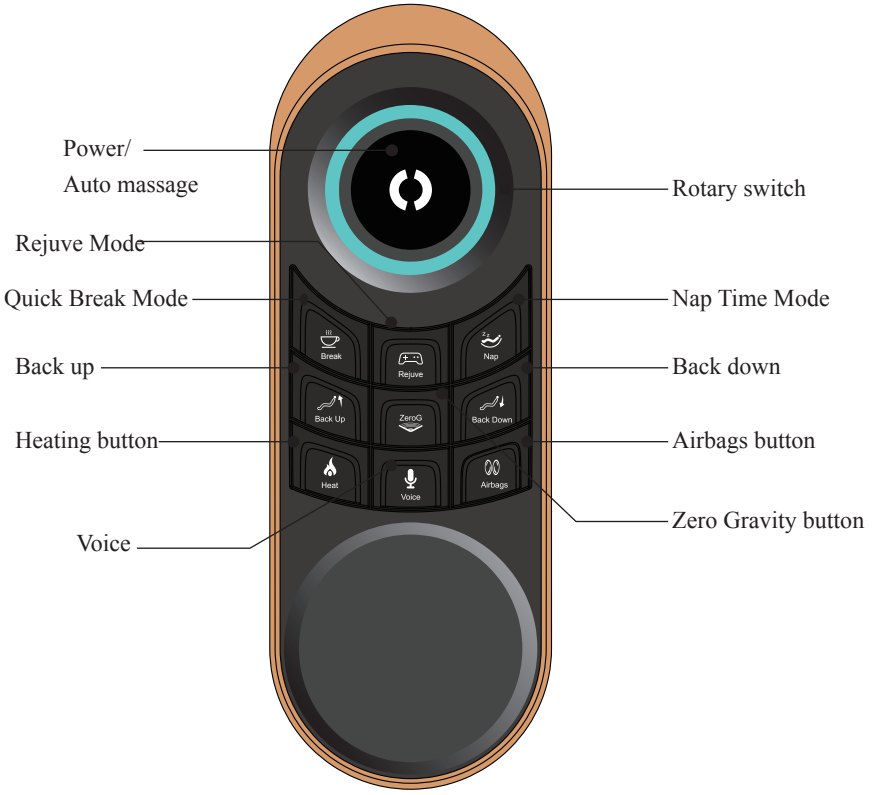

▶ NAME AND FUNCTION OF EACH COMPONENT

Instructions of Armrest Quick Buttons



Power/Auto massage

- ▶ When massage chair is connected to power, long press this button to power on the controller (white indicator surrounding the button lights up), then short press this button to start auto massage program, you may toggle among 15 pre-set auto massage programs. long press this button again to turn off the massage chair.



Rotary switch

- ▶ Rotate clockwise/counterclockwise to increase/decrease 4D massage intensity.



Break Mode

- ▶ Backrest slightly reclines, footrest lifts to a relaxing position to relieve the tension in the knee.



Rejuve Mode

- ▶ Backrest reclines to a proper position for playing with mobile device, there are less knocking in this mode to avoid moving of upper body.



Nap Mode

- ▶ Fully reclined position with gentle massage for napping.



Back Up

- ▶ Press and hold to raise the backrest to upright position; release the button to stop.



Zero Gravity Button

- ▶ Press this button to put the chair in Zero Gravity Level One Position; Press again to Zero Gravity Level Two Position; Press again to close the Zero Gravity Position.

▶ NAME AND FUNCTION OF EACH COMPONENT



Back Down

- ▶ Press and hold to recline the backrest; release the button to stop.



Heating Button

- ▶ When connected to power,press this button to turn on the back heat(red indicator lights up);press again to turn off the back heat(red indicator lights down).



Voice

- ▶ When massage chair is on, press this button to turn on the voice control and voice announcements of Armrest Quick Buttons. Press again to turn off both voice control and announcements.



Airbags Button

- ▶ When massage chair is on,press this button to cycle through 5 air pressure intensity settings.



WARNING

Do not operate the control panel with wet hands to avoid electric shock or injury.

Do not spill water or other liquid into the controller to avoid fault.

▶ Offline Voice Control

Voice Control

Voice device can be activated by touching the square shaped groove of microphone at left speaker or saying “Hi Osaki” or "Hey Osaki".

Voice commands list could be found in "Setting" page of tablet remote.

► FUNCTIONS AND FEATURES

Functions And Features

1.Slide Forward While Reclining

It can Slide forward while reclining to save space and provide utmost relaxing position.

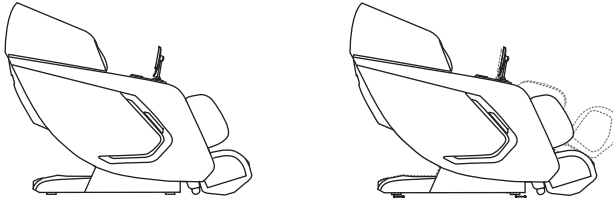

2.Human hand quad style massage rollers

Innovative Human hand quad style massage rollers and L-shaped sliding track conform to ergonomic principle.

3.Auto Extension Legrest

Legrest can extend by maximum 26cm automatically,fulfilling the need of diversified statures.

4. Air Pressure Massage

Air pressure massage for arms,calves and feet.

5.Roller Massage

3 underfoot rollers provide hand simulation rolling and shiatsu massage underfoot for the reflex zone.

6.Versatile Massage Techniques

Mimic human hand Fascia Rubbing,Shiatsu,Kneading,Sync,Tapping and Knocking massage techniques for custom-tailored relaxation.

7. Candy Bar Style Controller

Simple and Easy-to use controller, android system serves simple and easy to understand access to all functions.

8. Super Long Flexible L-Style Guide Track

PRELIMINARY CHECKS

Position & Placement for Installation

Clearance space for the massage chair:

- ▶ Ensure there is an adequate clearance for the installation: It needs 12cm clearance for the reclining of the backrest; It needs 62cm clearance space for the extension of footrest and sliding forward of the chair.
- ▶ Keep it 1 meter away from the TV, radio or other audio/video appliance to avoid signal interference.

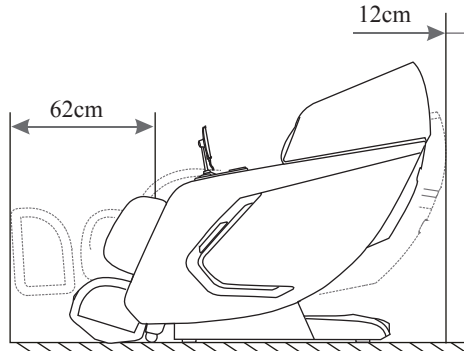

- ▶ Keep the distance between the power socket and power switch within 1.5 meter.

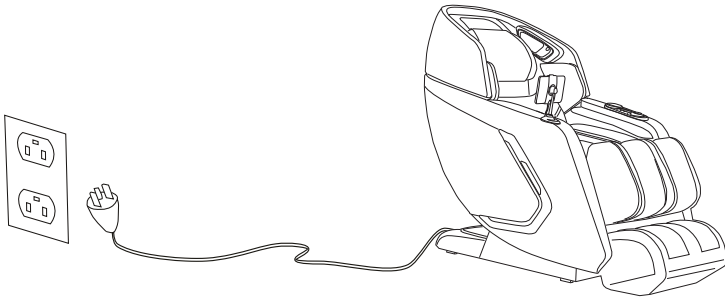

CAUTION

- ▶ Keep the distance between the power socket and power switch within 1.5 meter to avoid damage of power cord while massage chair sliding forward.
- ▶ Straighten the power cord while in use to avoid tangle or damage.
- ▶ When the massage chair sliding forwards or back, please check to make sure there are no children, pets or other obstacles around to avoid accident.

▶ PRELIMINARY CHECKS

Installation Method

Step 1, Take all massage chair units out of the cartons

- ▶ Unpack the cartons and take out all sewing and other accessories out of the cartons.

Step 2 , Install the Footrest Unit

- ▶ Lift the Footrest Massage Unit, fit the Hook of the footrest unit into the Coupling Shaft located at the Seat base(Keep the hook leveled with the coupling shaft), connect one side first then the other.

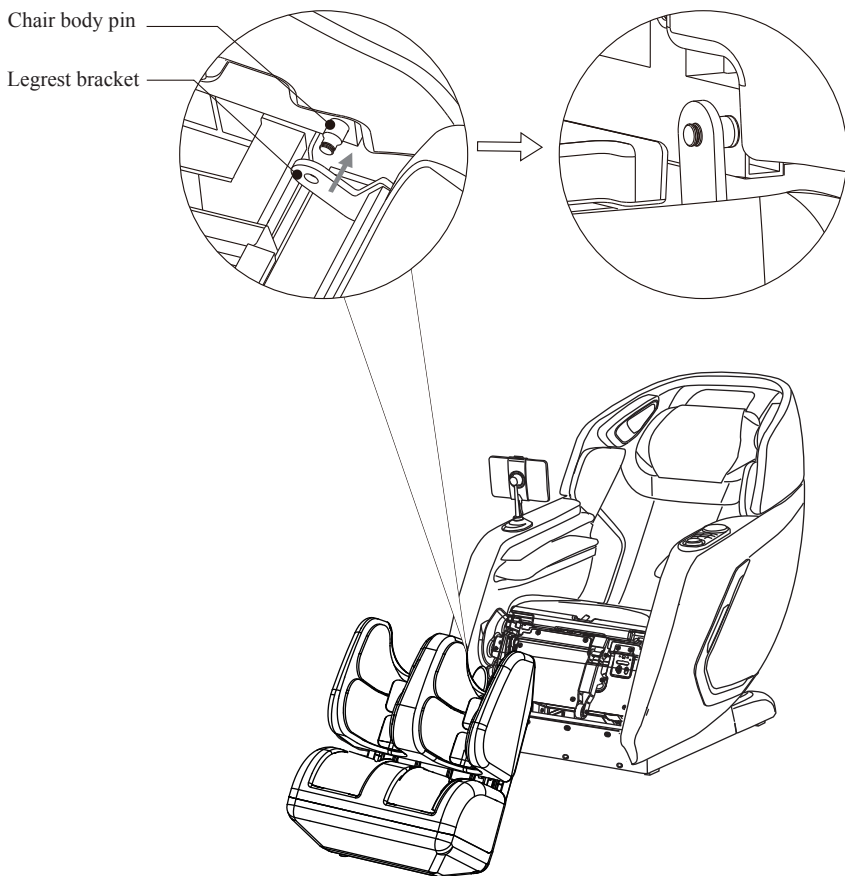

▶ PRELIMINARY CHECKS

Step 3 , Install the Legrest Unit

- ▶ Raise the footrest unit,thread the Air Hoses into the Air Nozzle,and fit the Air Valve plug into the Air Valve Port which located at the face side of seat base,make sure they are well secured.(Check the illustration below for reference)
- ▶ Zip up the cover and cushion.

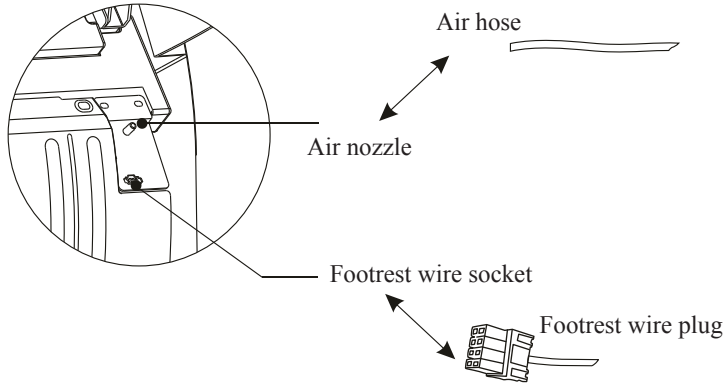

Step 4 , Install the controller unit

- ▶ Connect the controller cable to the massage chair's port(line up the pins with the port before connection),then tighten the screw cap clockwise to secure the connector in place.

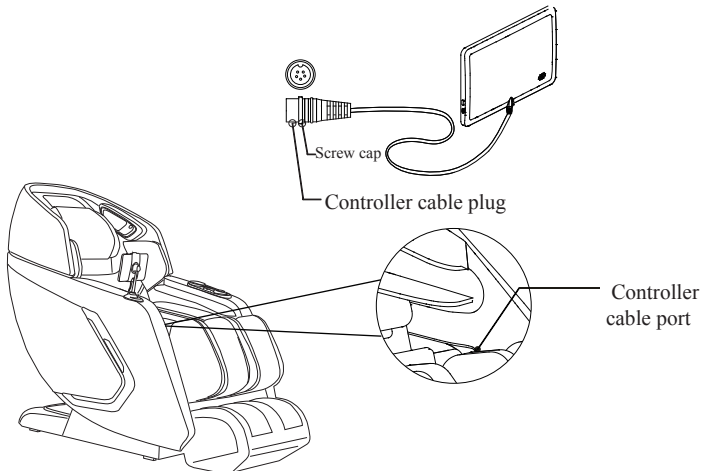

▶ PRELIMINARY CHECKS

Step 2, Install the Controller

- ▶ Insert the lower end of tablet holder into the socket,turn the locknut clockwise to secure the holder into place(make sure the cradle face to the chair side).

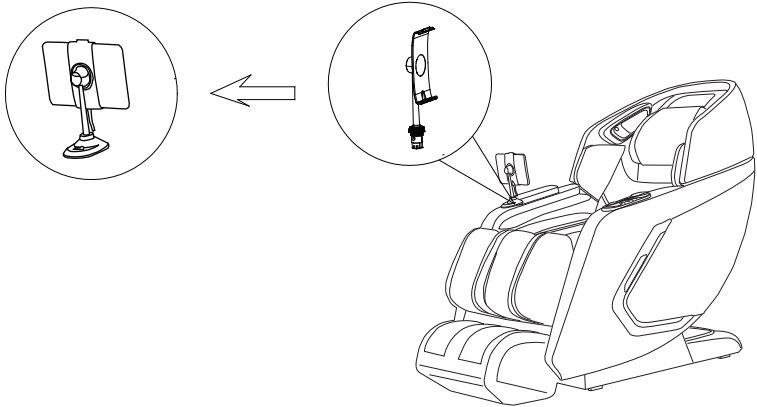

Step 6, Other Accessories

- ▶ Connect the power cable to the product power socket located at the power box.
- ▶ Connect power to chair,switch ON the power button,use the controller to raise the backrest to fully upright position.

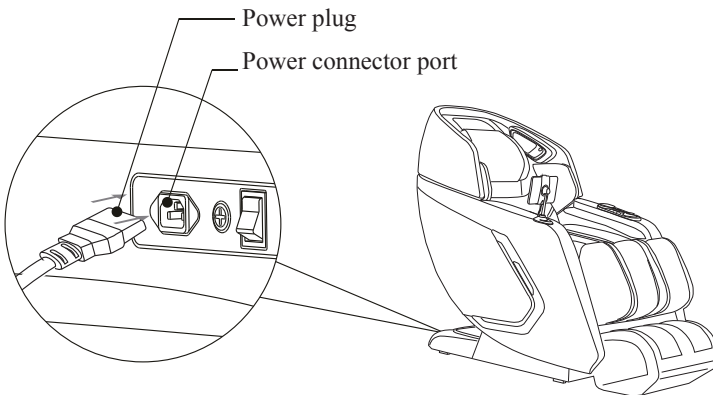

▶ PRELIMINARY CHECKS

Floor Protection

- ▶ We recommend to place a piece of carpet or soft mat underneath it to avoid damaging the floor.

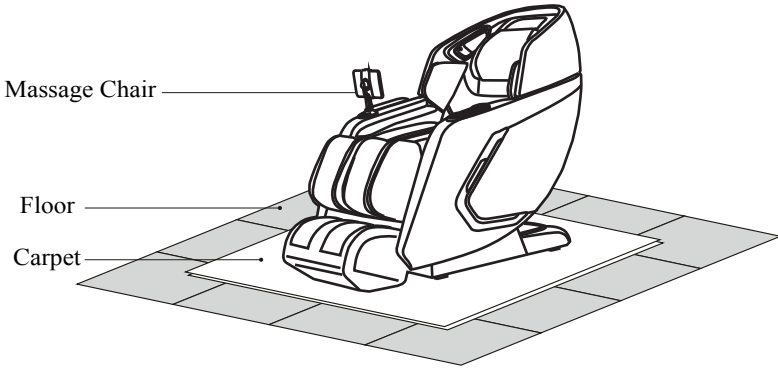

Surrounding Environment



Do not use the massage chair in high moisture environment such as near swimming pool or bathroom to prevent electric shock accident.



Please keep the massage chair away from heated surfaces to prevent fire hazard or damage to the product.

Grounding



This product must be grounded, the plug must be plugged into an appropriate 3-wire grounded outlet that is properly installed and grounded in accordance with all local codes and ordinances to reduce risk of electrical shock.

▶ PRELIMINARY CHECKS

Moving the Massage Chair

- ▶ Roll the chair on its casters to the desired location.
- ▶ Incline the backrest to upright position.
- ▶ Turn off the power switch and unplug the appliance from the electrical outlet.
- ▶ Using two people, push down on the backrest and lift up on the front side by grabbing the moving Holder located to the front bottom of the armrest, roll the chair on its casters to the desired location (check the sketch for reference).

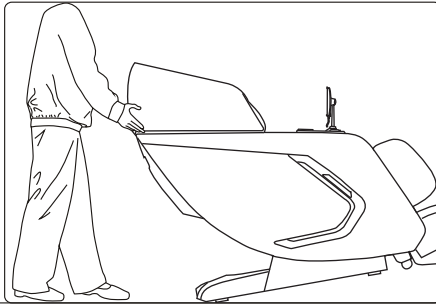

CAUTION

- ▶ Do not move the chair when there is user inside.
- ▶ To carry this product, do not lift by the footrest or armrest, hold the chassis and steady the backrest (have 4 or more people to carry the product).

Connecting to Power

- ▶ Connect this appliance to a 3-wire properly grounded outlet.
- ▶ Turn on the main power switch by the right hand side of the massage chair.

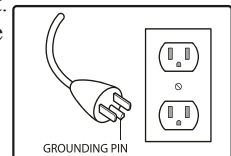

CAUTION

- ▶ Please verify that there is no damage to the supply cord before switching on the massage chair.
- ▶ Please verify that the main power switch is turned off before connecting to power.

▶ PRELIMINARY CHECKS

Commissioning

- ▶ Use the controller to recline the backrest to its lowest position, raise and extend the footrest to its top position, make sure there is enough clearance before commissioning.
- ▶ Return the backrest and footrest back to its default position after commissioning and turn off the power switch. To choose the massage program, please check the Instructions of Control Panel and Instructions of Touchscreen Controller for reference.

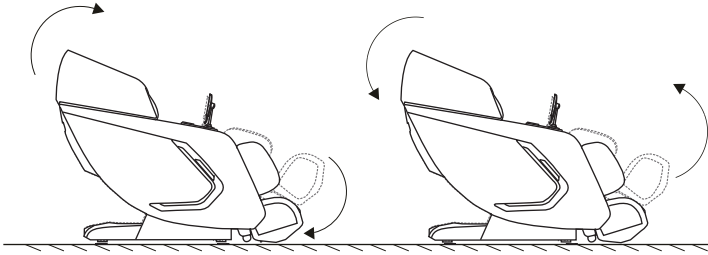

Before Sitting in the Chair

- ▶ Ensure the footrest is well assembled before sitting on the massage chair.
- ▶ Ensure the massage chair is returned to its original position before sitting on it.
- ▶ If there is any part not in default position, please turn off the massage chair to allow it to restore.

CAUTION

- ▶ Do not take seat while the legrest is lifted.
- ▶ Do not put excessive load on the legrest to avoid damage.

▶ PRELIMINARY CHECKS

Footrest Extension

- ▶ Press and hold “  ”button on the controller to extend or retract the footrest to the length you desire for better massage experience, release the button to fix the position.

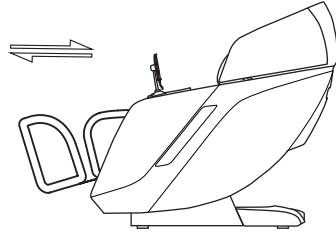
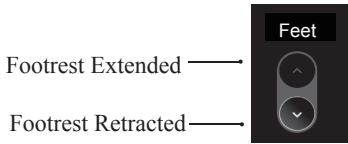

- ▶ A footrest sensor is set at the bottom of footrest, the footrest will adjust the length automatically once the chair started.



WARNING

- ▶ Do not play on the massage chair or operate it improperly.
- ▶ Ensure there is no obstruction when raising or reclining the backrest and footrest.
- ▶ Do not put foot, fingers or any other objects in the openings of the chair when it is in the reclining, raising or restoring motion.
- ▶ Ensure that massage chair is restored back to its original position before getting off the massage chair.

Audio Function

- ▶ To play sound, turn on bluetooth on your Android/Apple iOS device and place the massage chair in discovery mode to pair.

After Use

- ▶ Always unplug the massage chair from the electrical outlet immediately after use.
- ▶ Turn off the power switch and unplug the massage chair from the electrical outlet while not in use to avoid children power on the massage chair accidentally.
- ▶ When not in use for a long period of time, we recommend that the chair be covered, the power cord be coiled and that the unit be placed in an environment free of dust and moisture.

CARE AND MAINTENANCE

Care Instructions

- ▶ To treat stains on back panel,armrest,footrest,plastic parts or air hose,spot clean with mild detergent foam,then wipe it with a dry cleaning cloth.
- ▶ To treat stains on controller,power box,spot clean with a dry cleaning cloth.
- ▶ To treat stains on back cushion or pillows,use a water-based upholstery cleaner only,wipe it with moist cloth,then air dry.
- ▶ To clean the foot/calf unit covers,remove it from the chair,hand wash with a mild detergent, then line dry.



WARNING

- ▶ Children shall not play with the appliance. Cleaning and user maintenance shall not be made by children without supervision.
- ▶ Pull out the power cord from the power strips before care and maintenance.
- ▶ To avoid electrical shock or injury,do not touch the power cord with wet hands.
- ▶ Make sure no detergent enter into the power box while cleaning.
- ▶ Do not use benzene,thinner or other solvents on your product,it may cause fading or damage to the product.
- ▶ Do not iron the upholstery.

Storage Methods

- ▶ Cover the product with a dust-free cloth to prevent collection of dust if not in use of a long period of time.



CAUTION

- ▶ Do not leave this product exposed to direct sunlight for long periods of time. This may cause fading or damage.

Warm Tips

During daily use, please check for the following symptoms:

- ▶ Burnt smell.
- ▶ Power flickers on and off when touching the charging cable.
- ▶ The power cord is hot.
- ▶ Other abnormal symptoms.



CAUTION

- ▶ Please stop using the product to avoid breakdowns or accidents if any above symptom exists.
- ▶ Switch off the power button and disconnect the plug , contact the local distributors or supplier for repair.
- ▶ All other servicing except above care and maintenance should be serviced by an authorized dealer or service center.



WARNING

Pull out the power cord from the power strips before care and maintenance.
To avoid electrical shock or injury,do not touch the power cord with wet hands.
Do not try to dismantle or repair the product yourself,please send your massage chair to the authorized service center.

▶ TROUBLESHOOTING

No.	Symptoms	Possible Causes	Possible Solutions
1	Noise is heard while in use	This sound is normal and comes from the air pump motor or other mechanical parts rubbing against the cloth cover	No need to take any measures
2	Appliance does not start	The power cord is not secured into the socket	Insert the power plug properly into the power socket
		Power switch is off	Turn on the switch
		The fuse is blown	Replace only with a fuse of same type and rating
3	No music comes from the speaker	The volume is turned to the lowest	Adjust the speaker volume from the mobile devices
		Bluetooth is off	Switch on Bluetooth
		Bluetooth connected with other device	Reconnect Bluetooth
4	Backrest or footrest can not raise or recline	Excessive load has been pressed on the backrest or legrest	Reduce the load and try again

If problem remains, please contact the dealer for maintenance.

Important: Do not attempt to repair this product yourself, our company shall not be liable for the injury or damage caused by any servicing without authorization.

▶ TECHNICAL SPECIFICATIONS

Product name: Osaki Massage Chair

Model number: 4D Bravo Duo®

Rated voltage: 110-120V~

Rated frequency: 60Hz

Rated current: 1.6A